

200W-FSM Single Output Switching Power Supply
200W-FSM 单路输出开关电源

HF200W-FSM Series
HF200W-FSM 系列



215x115x30 mm

UL CB CE

■ **Electrical Specifications 电气规格**

Input Voltage 输入电压	90~132/180-264VAC by switch 通过开关选择
Input Current 输入电流	< 4.0A/115VAC, 2.0A/230VAC
Input Frequency 输入频率	47~63Hz
Inrush Current 启动冲击电流	cold start, 60A/230V 冷启动, 60A/230V
Input Leakage Current 输入漏电流	< 2mA/230VAC
Line Regulation (full load) 电网调整率 (满载时)	± 0.5%
Voltage Adjust Range 输出电压调节范围	± 10%
Output Overload Protection 输出过载保护	105~140%, hiccup mode, auto recovery 打嗝模式, 自恢复
Output Over Voltage Protection 输出过压保护	115~150%, hiccup mode, auto recover 打嗝模式, 自恢复
Short Circuit Protection 短路保护	hiccup mode, auto recovery 打嗝模式, 自恢复
Rise Time 上升时间	50ms@ full load (typical) 50ms@ 满载时 (典型值)
Hold up Time 保持时间	20ms@ full load (typical) 20ms@ 满载时 (典型值)
Mechanical Feature 机械特性	metal enclosed 金属外壳
Dimensions 外形尺寸	215 x 115 x 30mm (L x W x H)(长 x 宽 x 高)

■ **Features 产品特性**

- AC input range selected by switch
通过开关选择交流输入范围
- Super slim, 30mmS height, high reliability
超薄设计, 高度仅 30mm, 高可靠性
- Built-in EMI filter 内置 EMI 过滤器
- Top international brand components for key parts
关键元器件使用国际知名品牌元器件
- Protections: overload/ over voltage/ short circuit
保护方式: 过载、过压、短路保护
- 5 years limited warranty 五年有限责任质保
- High operating temperature up to 70°C
工作环境温度最高可达 70°C

Operating Temperature 工作温度	-30°C ~+70°C (ref. derating curve) (参见减额曲线)
Storage Temperature 储存温度	-40°C ~+85°C
Operating Humidity 工作湿度	20%~93%RH (non condensing)(无凝露)
Storage Humidity 储存湿度	20%~95%RH (non condensing)(无凝露)
MTBF 平均无故障工作时间	>100,000 hours >100,000 小时
Cooling Method 冷却方式	convection 自然冷却
Safety Standards 安全标准	GB4943,UL62368-1,UL60950, EN60950
EMC Standards 电磁兼容标准	GB9254, EN55032 Class A EN55014, EN61000-3-2, 3 EN61000-4-2, 3, 4, 5, 6, 8, 11
Withstand Voltage 绝缘强度	I/P -O/P: 3.0KVAC/1min I/P - PE: 1.5KVAC/1min O/P-PE: 0.5KVAC/1min
Vibration 振动	10~150Hz, 2G 10min / 1cycle, 30min each along X, Y, Z axes 10~150Hz, 2G 10 分钟 / 周期, 30 分钟 / X, Y, Z 轴每个方向
Connection 接线端子	9P/9.5mm screw terminal block 9P/9.5mm 螺丝接线式接线端子
Screw/Torque 螺丝 / 扭力	M4/1.2N·m
Wire 接线范围	22-11AWG 4.0mm ²
Weight & Packing 重量 & 包装	0.63kgs 每台, 20pcs/14.0kgs/ 0.03CBM per carton 每箱

Model No. 型号	DC Output 直流输出	Rated Power 额定功率	Load Regulation 负载调整率	Voltage Tol. 电压精度	Ripple & Noise 纹波和噪声	Efficiency 效率
HF200W-FSM-3.3	3.3V 40.0A	132.0W	±2.0%	± 1%	150mVp-p	80%
HF200W-FSM-5	5V 40.0A	200.0W	±2.0%	± 1%	150mVp-p	80%
HF200W-FSM-12	12V 17.0A	204.0W	±1.0%	± 1%	150mVp-p	85%
HF200W-FSM-15	15V 14.0A	210.0W	±0.5%	± 1%	150mVp-p	86%
HF200W-FSM-24	24V 8.8A	211.2W	±0.5%	± 1%	150mVp-p	87%
HF200W-FSM-36	36V 5.8A	208.8W	±0.5%	± 1%	200mVp-p	87%
HF200W-FSM-48	48V 4.4A	211.2W	±0.5%	± 1%	200mVp-p	88%

* Other output voltage also available 其它规格均可定制。

Drawing 安装图纸

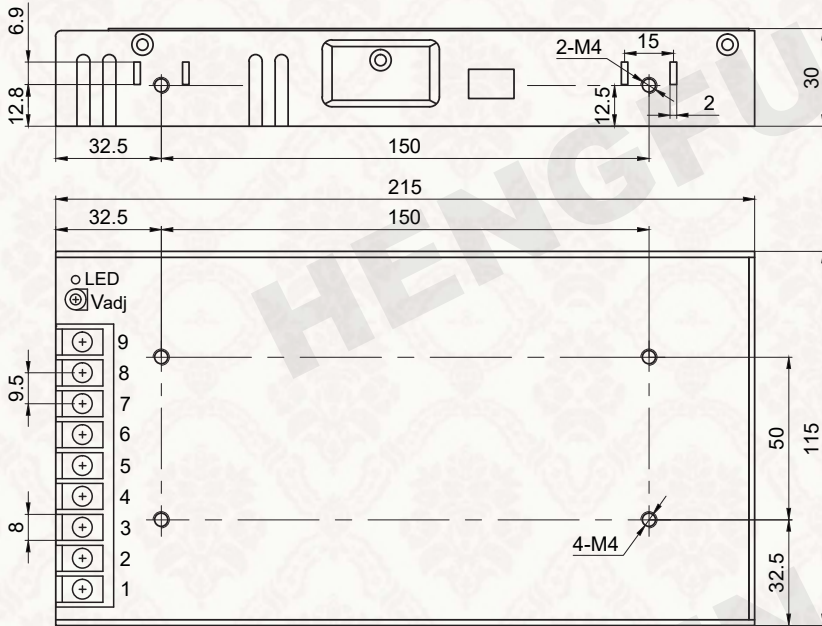

注意：
安装螺丝进入
机壳长度≤3mm
螺丝刀扭矩≤1.0N·m

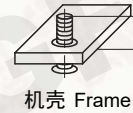

机壳 Frame

NOTICE:
Mounting screws into
frame max.3mm.
Screwdriver Torque max.1.0N·m

Terminal Pin No. Assignment 接线端子排布:

Pin No. 位号	Assignment 排布	Pin No. 位号	Assignment 排布	Pin No. 位号	Assignment 排布
1	AC/L	4	DC OUTPUT -V	7	DC OUTPUT +V
2	AC/N	5	DC OUTPUT -V	8	DC OUTPUT +V
3	PE	6	DC OUTPUT -V	9	DC OUTPUT +V

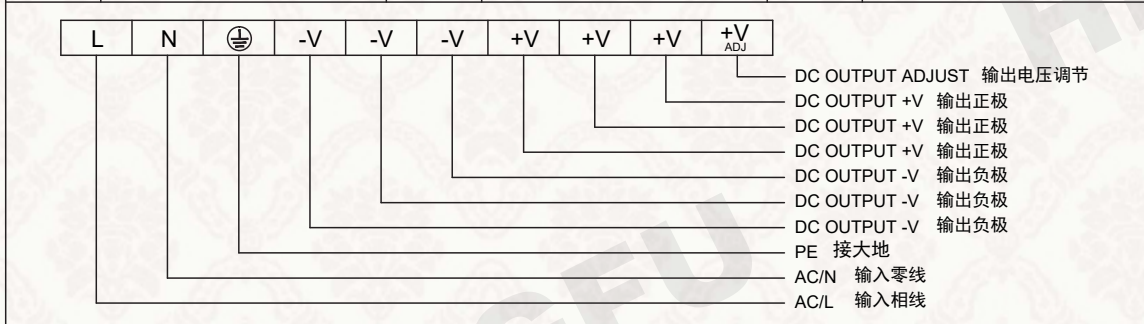

Model Code 型号编码

HF200W-FSM-12

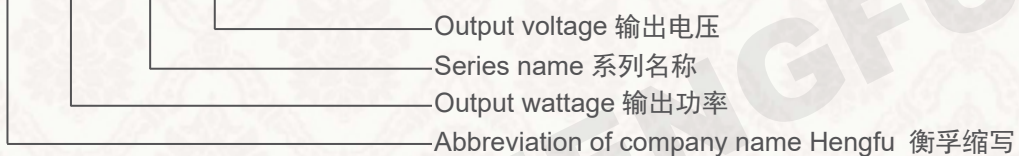

Derating Curve 减额曲线

Static characteristics 静态特性曲线

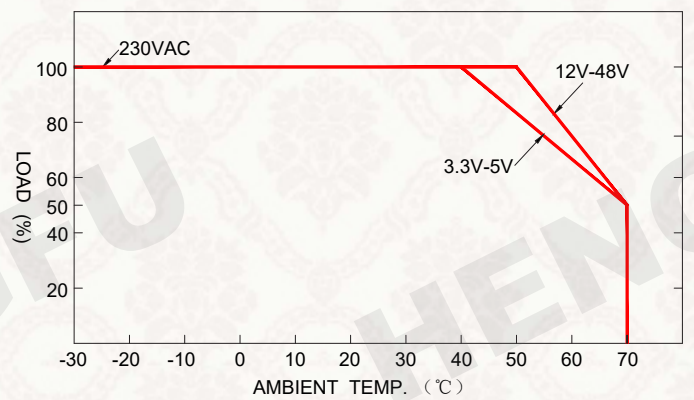
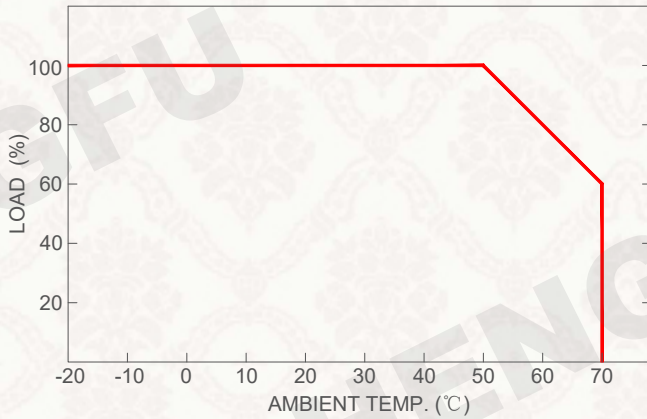

Block Diagram 方框图

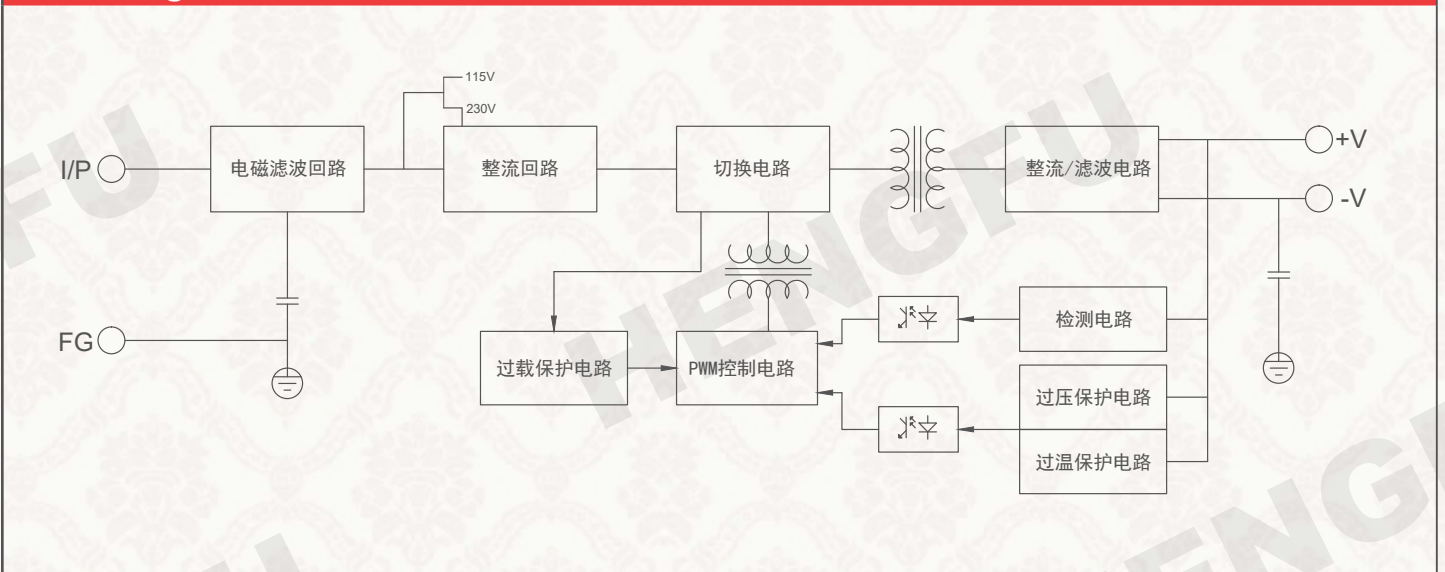

Note 备注

- All parameters are measured at 230VAC input, rated load and 25°C ambient temperature.
上述所有参数的测试条件为 230VAC 输入电压，额定负载和 25°C 室温。
- Line regulation is measured from low line to high line at rated load.
电网调整率是在额定负载条件下从低电网到高电网的输出电压变化率。
- Load regulation is measured from 0% to 100% of rated load for single output models.
负载调整率是负载电流从额定负载的 0% 到 100% 变化时的输出电压变化率。
- Ripple & noise are measured at 20MHz of bandwidth by using a 30cm twisted pair-wire terminated with a 0.1uF & 47uF parallel capacitor.
纹波和噪声是用 20MHz 带宽的示波器，通过一根 30cm 长的末端并接 0.1uF 和 47uF 电容的双绞线进行测量的。
- The power supply is regarded as a component which will be installed into the final equipment. The final equipment must be re-confirmed that it still meets EMC directives.
开关电源被视为整机的一个部件。整机是否符合 EMC 指令还需重新测试并验证。
- To learn more about the products, please visit www.hengfu.com to read the relevant contents of Product Instruction Manual and Service Commitment.
如需了解产品的更多信息，请登录公司官网 www.hengfu.com 阅读《产品使用说明及服务承诺》的相关内容。
- For more information, please scan the QR code or call our service hotline at 400-889-1788.
更多资讯请扫描二维码或拨打服务热线：400-889-1788。

